



# Winter

**AIR - CONDITIONING &  
REFRIGERATION L.L.C.**

**“ We are specialists in Refrigeration,  
Process Cooling & Air-Conditioning ”**

## • Scope of Experience

For the past 30 years Winter-Airconditioning & Refrigeration, LLC has been providing refrigeration and cooling solution throughout the MENA region. we take pride in being one of the very few vertically integrated companies of the region representing leading international brands. Equipped with state-of-art engineering capabilities and perfect understanding of refrigeration and air conditioning processes we design, install and maintain a wide range of refrigeration products like water chillers, glycol chillers, icemakers, air units, plate freezers, spiral freezers, tunnel freezers, hygienic air handlers with 100% fresh air capabilities.

### Industrial Refrigeration



**Marine Refrigeration**

**Air Conditioning**

With an ever expanding customer base and fostering strong alliances with our partners, winter promotes a healthy culture both within the organization and to the outside world as well. We are always open to new businesses or networking opportunities at both the corporate and individual level.

## • Quality and Customer Satisfaction

Our key aim is customer satisfaction which we achieve by delivering tailored turn-key solutions while adhering to the highest standards of quality and using the best products, which include world class refrigeration compressors and control systems.



Our record of almost zero loss to production or business amongst our clientele is a testament to Winters quality customer training and a highly skilled maintenance team ready to respond any time at any location.



our scope of business ranges from providing maintenance for existing facilities to green field projects.



# Design & Engineering

Our highly skilled team of engineers will bring the refrigeration idea into reality. Our priority is to meet all your requirements and go beyond expectations by translating your requirements into engineering.

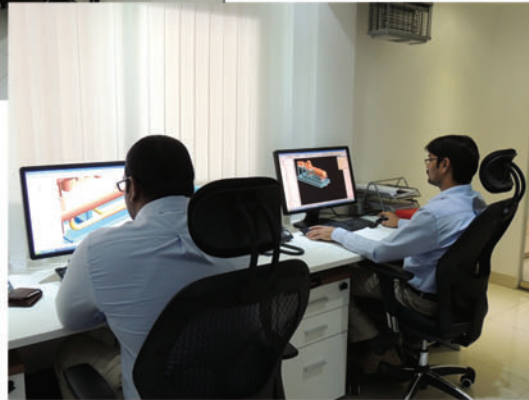
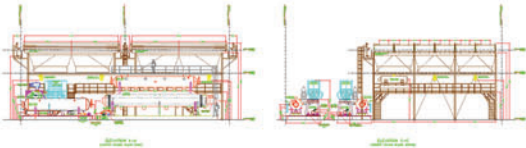
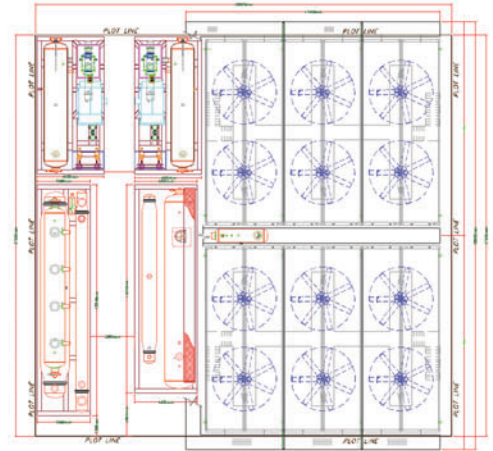

Our experienced engineers will design the entire system from heat load calculation, equipment selection, control and management till the calculation of efficient energy consumption, ensuring maximum efficiency and reliability giving complete attention to the finest details that are centered on your requirements.

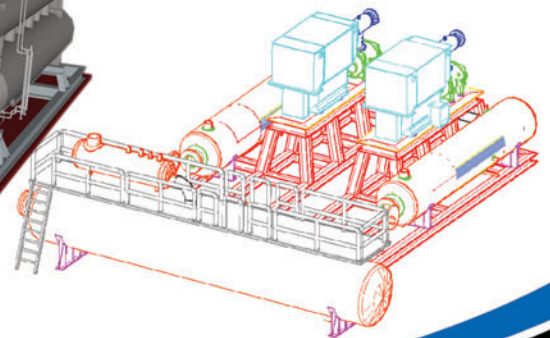
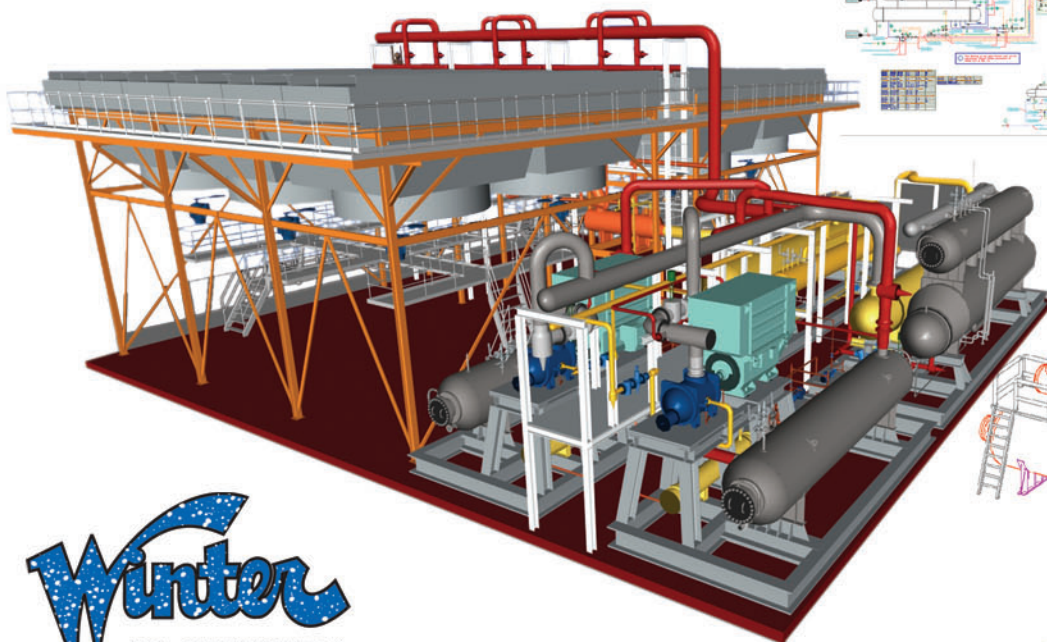
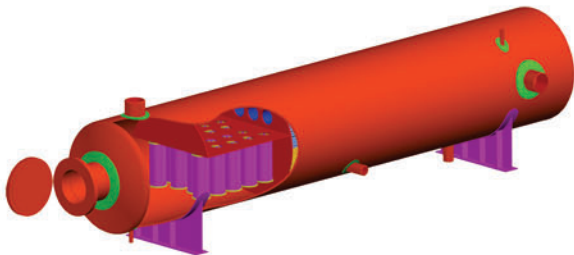
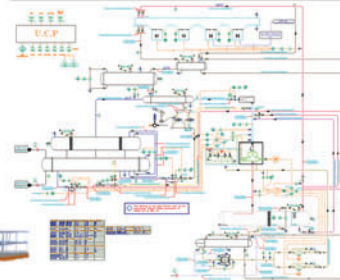

# Fabrication & Installation

Our expert team of installers are highly experienced service professionals with a perfect understanding of meeting your refrigeration requirements.

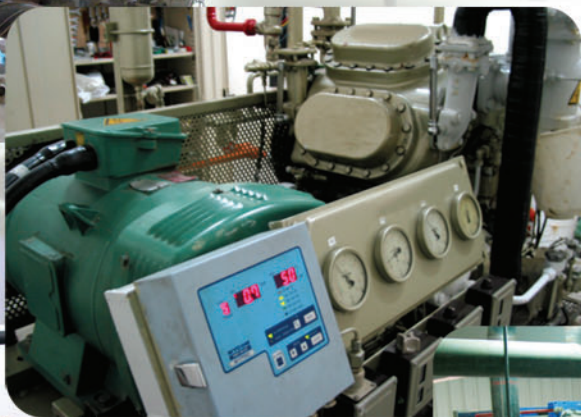

We make sure that your needs are addressed with professionalism and high customer satisfaction that gives the best value for your money and are taken care on time with perfection.



# Spare parts

We provide a wide range of spare parts whether it is a part of a compressor made in the 1930's or a control valve that has just come out of a new product line, we can certainly fulfill your requirement for most parts the same day, or next day if required. Contact us for any of your refrigeration spare parts needs and we will gladly help you out.

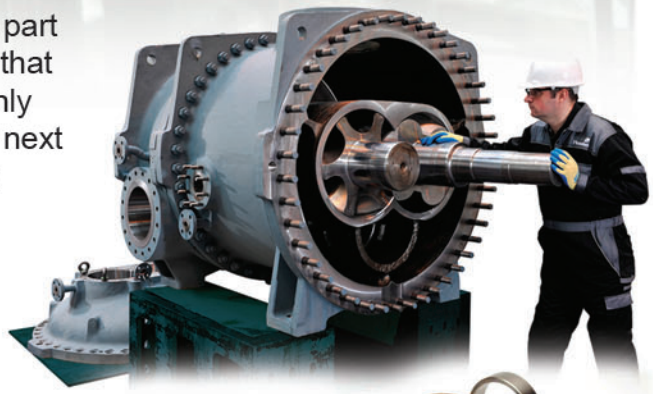

## • Ice & Snow Making

From hotels, restaurants, supermarkets and fast food outlets, to hospitals, laboratories, fisheries and food processing facilities, ICE plays a crucial role in the maintenance of perishable food items. We provide our customers with optimal and timely solutions with our professional ice making facilities.



Our ice manufacturing systems preassembled in 40 foot containers are easily transportable by trucks. They are specially designed for easy installation and removal making them highly suitable for operations in remote locations.



Flake Ice Maker



In recent years the concept of year round indoor ski center or skating rings promoted us to use our engineering strength to involve ourselves for this highly demanded sports which is getting more popular in Middle East region and today we are ready to provide complete system to our client.



Snow Making System



Block ice is often demanded in various industry. Specially with our pre fabricated ice plant system which combines of less and higher production with less power consumption will provide higher profit margin to our client while easy operation giving greater customer satisfaction.

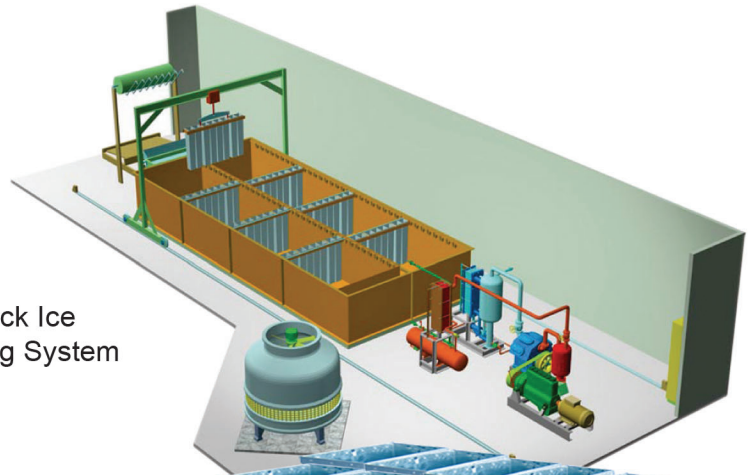

Block Ice Making System

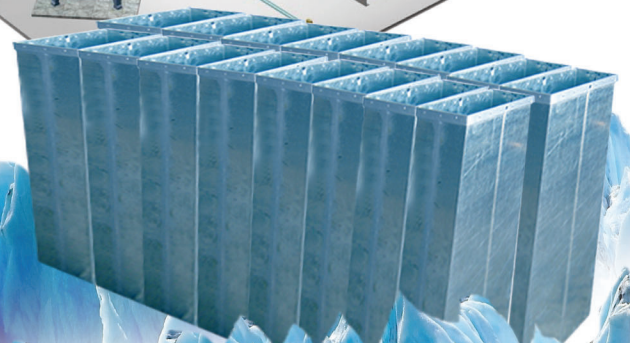
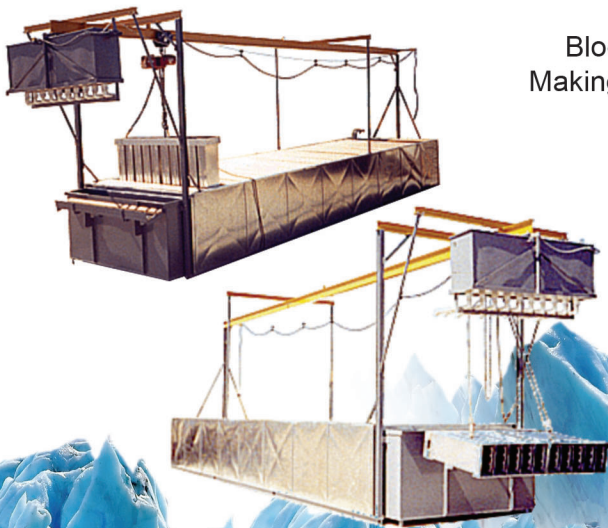

# Agricultural & Food processing



In recent decades food industry has experienced tremendous change at various levels with a continuous and regular market demand for more advanced and diversified refrigeration facilities.



With our years of experience in providing world class refrigeration solutions, our ability and expertise in designing and building such facilities for our clients has earned us a special place in the region.

Building on the wealth of technology and industry expertise available with us, we continue to develop and enhance total thermal engineering technology by providing extensive automation and thereby reducing manpower cost for all our clients cooling needs.



Slaughter house refrigeration system



Bakeries Refrigeration System



# Cold Storage

Cold storage is an important element of the food distribution network. Rapid development and advances in thermo technology, food engineering and innovative refrigeration equipment have made it practically possible to keep the foodstuff fresher for long periods of time.



Most of today's cold storage plants to maintain correct level of temperature deploy two stage refrigeration-system composed of booster and high stage compressor or internally compounded

We use highly durable compressors to support our clients with their maintenance needs and provide them with sophisticated system of refrigeration.



Fresh fruit & vegetables agricultures being highly perishable products prefer pre-cooling systems.



This requires refrigeration facility that is sufficient to cool the product as fast as possible. Winter refrigeration pre-cooling system designed for fast cooling along with very high humidity as almost 100% which will provide preservation and less weight losses.



# Equipments

Purchasing a new refrigeration equipment replacing the existing one, or purchasing a new system for expansion is a serious decision that can have many variables. With specialized knowledge in customized ammonia refrigeration systems and other Gas refrigeration services we make sure with our experience, knowledge and dedication to work with you and the manufacturer that the right piece of equipment with right options is delivered to you on time for the best price available.



With an uncompromised focus on providing our customers the best service and exceptional quality we have a dedicated after sales staff whose excellent performance and efficiency has assisted us in every step.



Special Packages



Air Cooled Condenser



Screw Packages



Air Cooler

# Screw Packages & Chiller



WRV 510  
Largest in industry

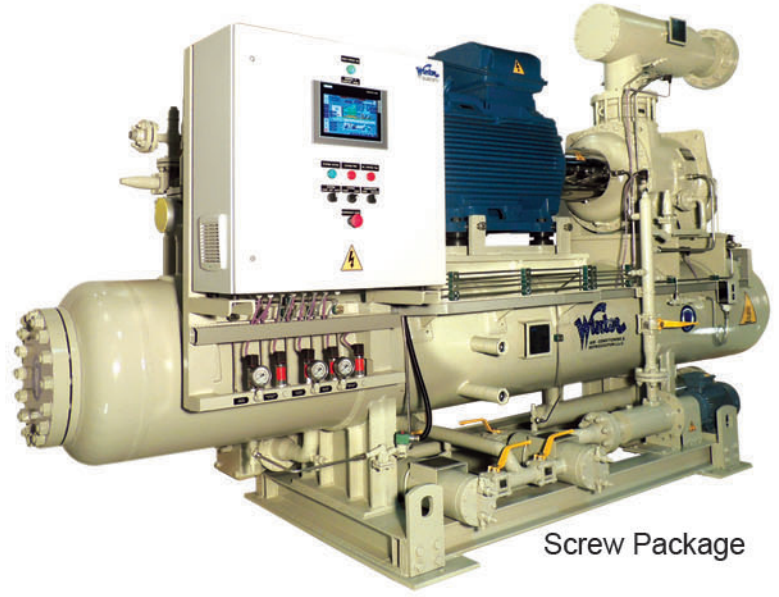

Screw Package



Bare WRV

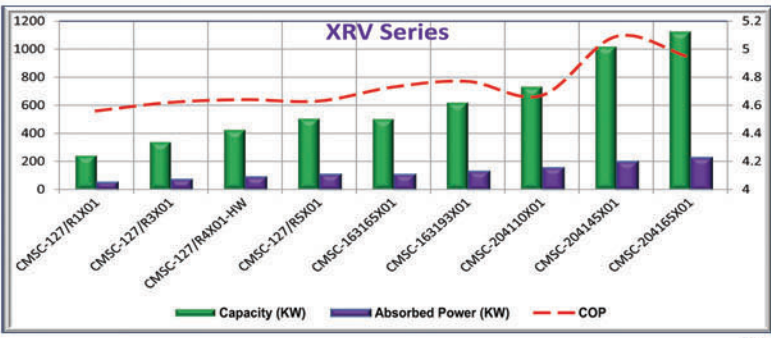
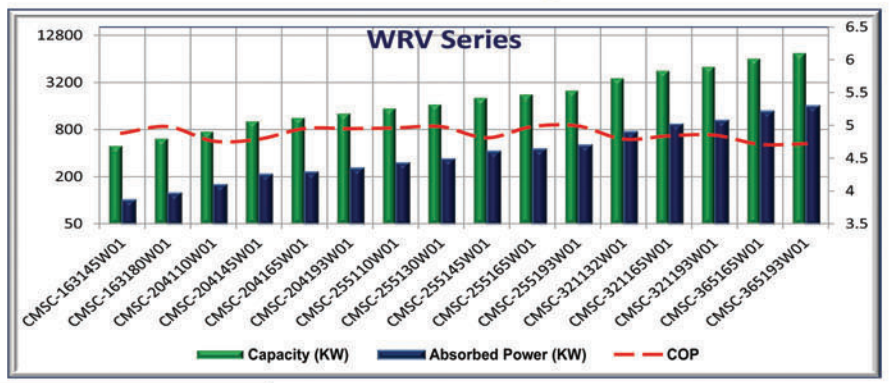

Bare XRV



cascade NH3 chiller

## Evaporative Cooling Equipment

EVAPCO is a worldwide manufacturer of industrial and commercial cooling equipment since its founding in 1976. EVAPCO's success has been the result of its dedication to research and development, qualified personnel and commitment to provide the highest level of quality and service in the industry.

As an agent of EVAPCO, we provide cooling tower products line which is an advanced technology design that utilizes induced draft counterflow technology-the most efficient in the industry and the best design for operation in a freezing climate. the counterflow design provides the inherently better operational and maintenance features.

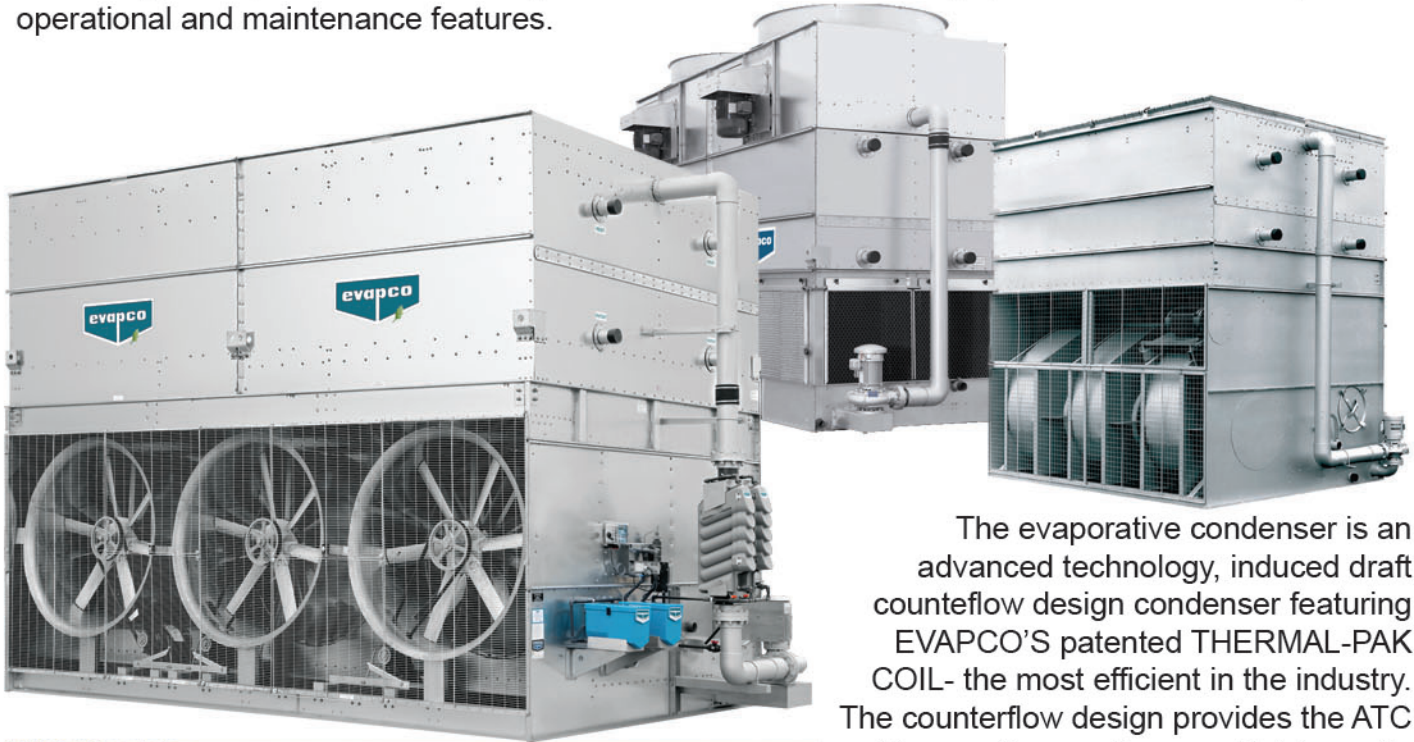

The evaporative condenser is an advanced technology, induced draft counterflow design condenser featuring EVAPCO'S patented THERMAL-PAK COIL- the most efficient in the industry. The counterflow design provides the ATC Evaporative condenser with inherently better operational and maintenance features.

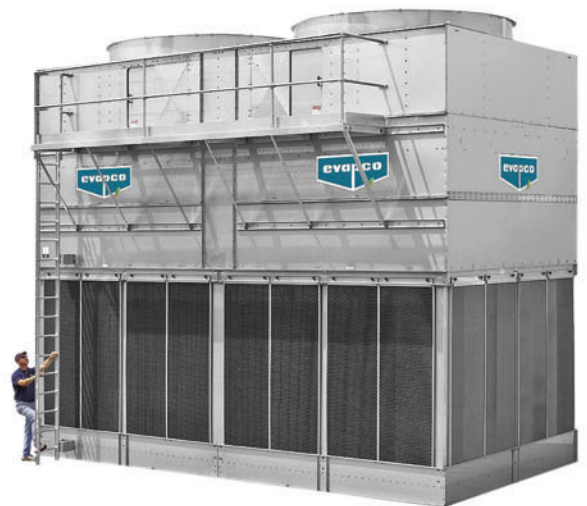

Evapco serves the worldwide air-conditioning industrial process cooling, thermal storage and industrial refrigeration market.



We are Refrigeration, Process Cooling  
&  
Air conditioning Specialties

Winter Air Conditioning & Refrigeration L.L.C

Head office : P.O.Box: 39156, Dubai - U.A.E

Tel :+971 4 324 1075 Fax: 971 4 324 1083. Email : [info@winter.ae](mailto:info@winter.ae)